



AiM Infotech

Formula Renault FR2000 speed sensor technical documentation

Release 1.01



SENSOR DOCUMENTATION	31/01/2005	SPEED	Magnetic phonic wheel for FR2000
Notes: Formula Renault FR2000 speed sensor technical documentation, dimensions and pinout. – Version 1.01			

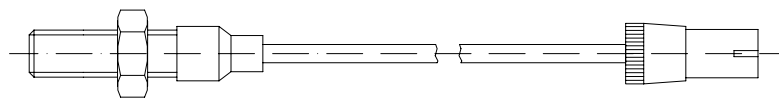

Figure 1: Speed sensor (magnetic phonic wheel) for Formula Renault 2000 applications (side view)

Introduction

The magnetic phonic wheel speed sensor is an instrument properly designed to be used on Formula Renault 2000 cars. This is a “non contact” devices and needs a magnetic trigger to pass the sensor face.

The instrument’s measure range is included between 8 and 15 mm; the speed sensor is supplied with a 1700 mm long cable.

Kit description

Inside the “FR 2000 phonic wheel speed kit” you will find the following objects:

- 2 cylindric magnetic phonic wheels;
- 2 brackets, used to install the sensor;
- 2 speed sensors, supplied with a 1700 mm long cable;
- 1 “double speed” cable, to plug the two speed sensors in a single input.

Installation notes

- Install the two phonic wheels coaxially to the front wheels hub;
- Install the bracket;
- Mount the sensor on the bracket: please ensure that the distance between the sensor and the phonic wheel is included between 8 and 15 mm and then fix the sensor on the bracket using 2 M8 locknuts;
- Plug the two speed sensors in the “double speed” cable. Then plug the “double speed” cable in your instrument (EVO 3 / Drack) “Speed” input.

In **Figure 2** is reported a speed sensor installation drawing.

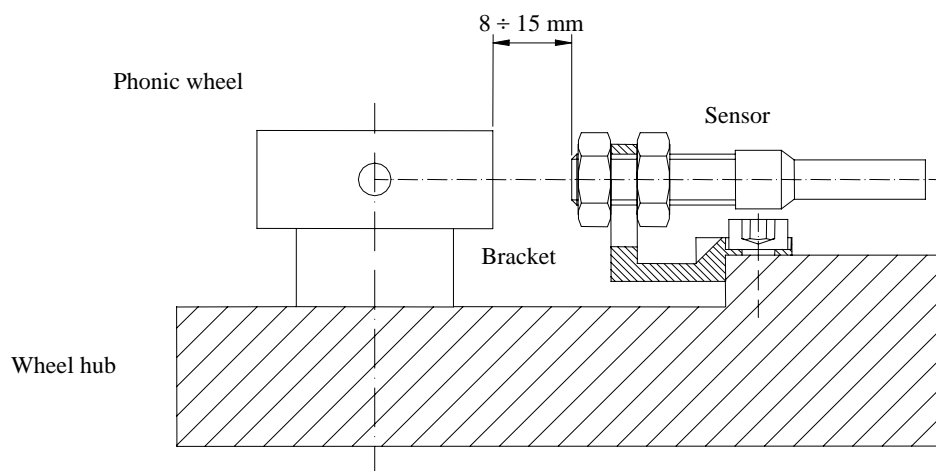

Figure 2: installation of speed sensor (magnetic phonic wheel) for Formula Renault 2000 applications

Note: when plugging the cable in the data logger, please pay a particular attention in inserting the cable inside the front-cockpit, so to avoid damages to the speed cable.

Software

Once the speed sensor has been installed and plugged in your data logger, to acquire consistent and correct information, it needs to be configured. To do so, please use **Race Studio 2**, the software properly developed by Aim to configure its instruments and analyze stored data.

Race Studio 2

In **Race Studio 2** main window, reported here below, you can choose your instrument. Please select your instrument and press “System manager” button.

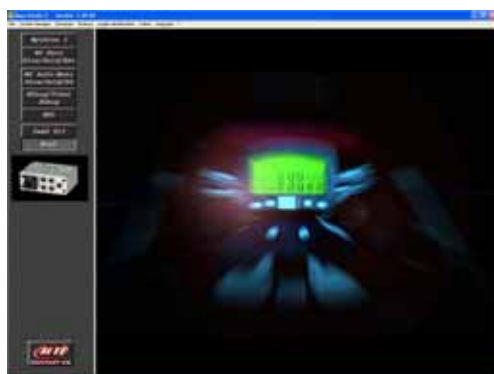

You are requested to set two parameters:

- *Number of pulses on wheel revolution*: this function allows you to set the number of pulses per wheel revolution. The magnetic phonic wheel generates two pulses per wheel revolution; for this reason, please set the “number of pulses per wheel revolution” to **2**.
- *Wheel circumference*: this option allows you to set the wheel circumference (in mm or in inches). This value is fundamental to correlate the wheel revolution speed and the car speed. A typical FR2000 wheel circumference value is **1670 mm (65.7”)**.

Once the correct wheel circumference value and the number of pulses set, please transmit the configuration to the instrument pressing “Transmit” button.

Sensor configuration

In “System manager” main window, press “Channels” button to set the sensor you have installed on your vehicle. The following screenshot appears.

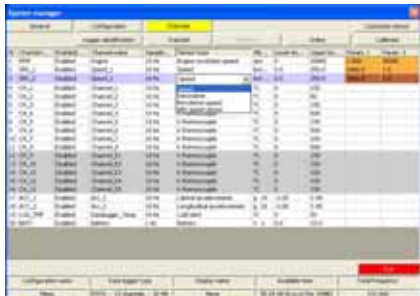

Here follows a short description of the speed sensor configuration procedure for the following data logger:

- **EVO 3 8c MS / 13c PLUS**

To configure the speed sensor, please click twice in the “Param 1” column and in the row corresponding to the “speed” channel. The following screenshot appears:

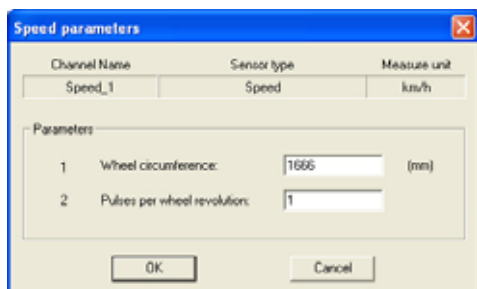

Dimensions

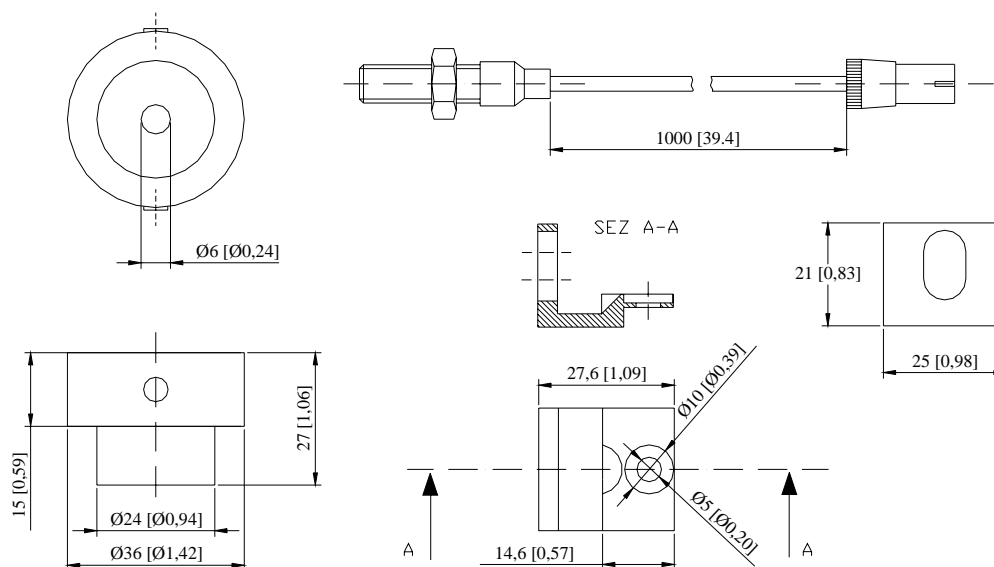

Dimensions in millimeters [inches]

Connector details

Pin	Function	Pin	Function
1	Speed	3	V battery
2	GND	4	n.c.

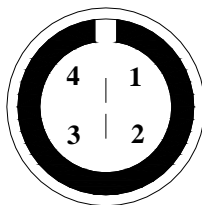

4 pins Binder 719 male connector: solder termination view

Technical characteristics

Electrical characteristics	Value
Sensing distance	From 8 to 15 mm
Number of pulses per revolution	2

Mechanical characteristics	Value
Cable length	1700 mm